



2026
TECH ED
SYMPOSIUM &
VENDOR
SHOWCASE



2026 ISPE-Midwest Tech Ed Symposium & Vendor Showcase

Tuesday, May 19

Overland Park Convention Center

Krishna Bell

- Mom, wife, daughter, sister
- Super Nerd — Biologist
 - Prairie restoration
 - Chicken and Garden Keeper
 - Technical sales 20+ years
- ISPE
 - Midwest Membership Chair
 - OSD COP Group
- St Sabina Church
- Financial Peace University
- Great Dane Rescue



2026 ISPE-Midwest Tech Ed
Symposium & Vendor Showcase

Tuesday, May 19

Overland Park Convention
Center

Agenda

- **NDA's- no proprietary info discussed** 
- **What is a GLP1?**
- **Pharma strategy by company**
- **Equipment specifications**
- **Q&A**

Trivia
Vocabulary

**2026 ISPE-Midwest Tech Ed
Symposium & Vendor Showcase**

Tuesday, May 19
Overland Park Convention
Center

Biology Lesson.... And Cake!

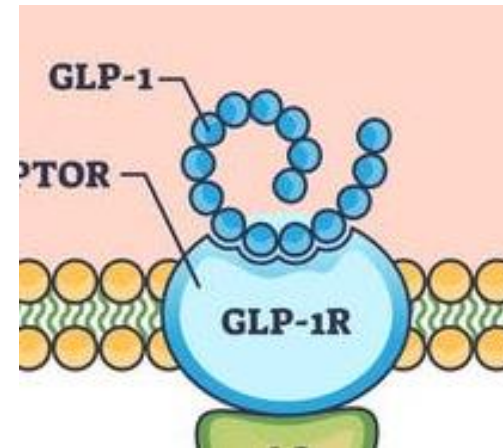
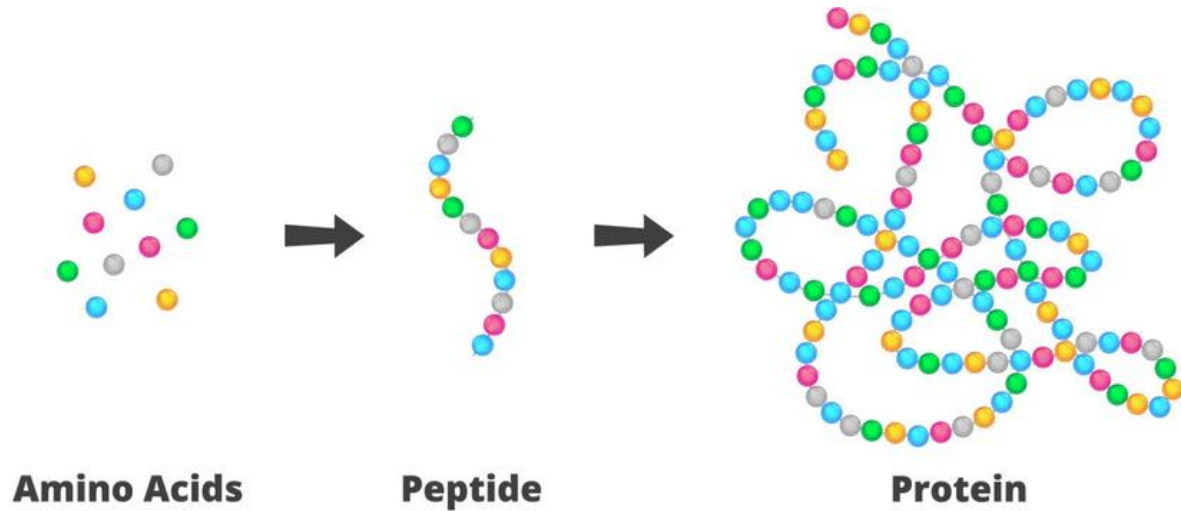

2026 ISPE-Midwest Tech Ed
Symposium & Vendor Showcase

Tuesday, May 19
Overland Park Convention
Center

GLP-1 – What is it?

Glucagon-like peptide-1

GLOO-kah-gon

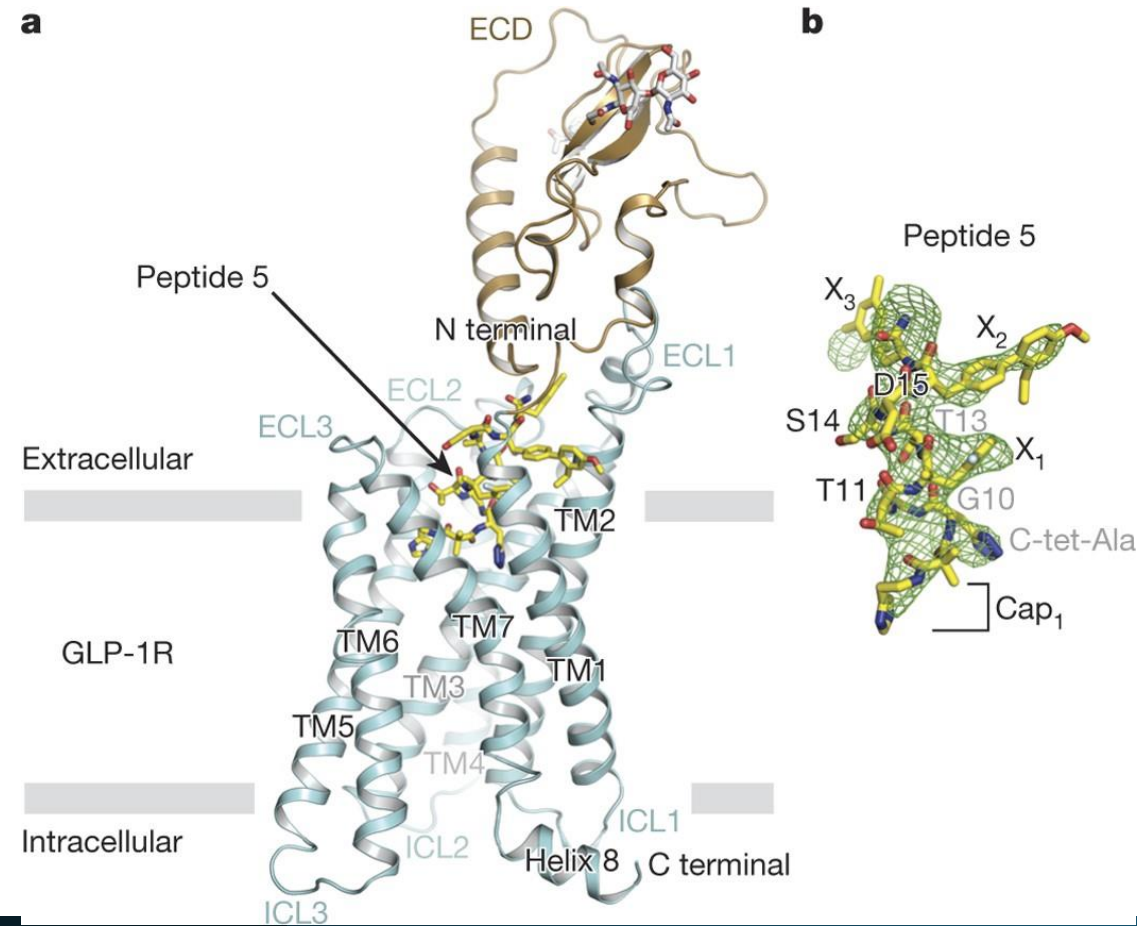

2026 ISPE-Midwest Tech Ed
Symposium & Vendor Showcase

Tuesday, May 19
Overland Park Convention
Center

What is an Agonist vs an Antagonist?

- A. An agonist activates a receptor**
- B. An antagonist blocks a receptor**
- C. An antagonist swaps raisins for chocolate chips in cookies**
- D. Both A and B**



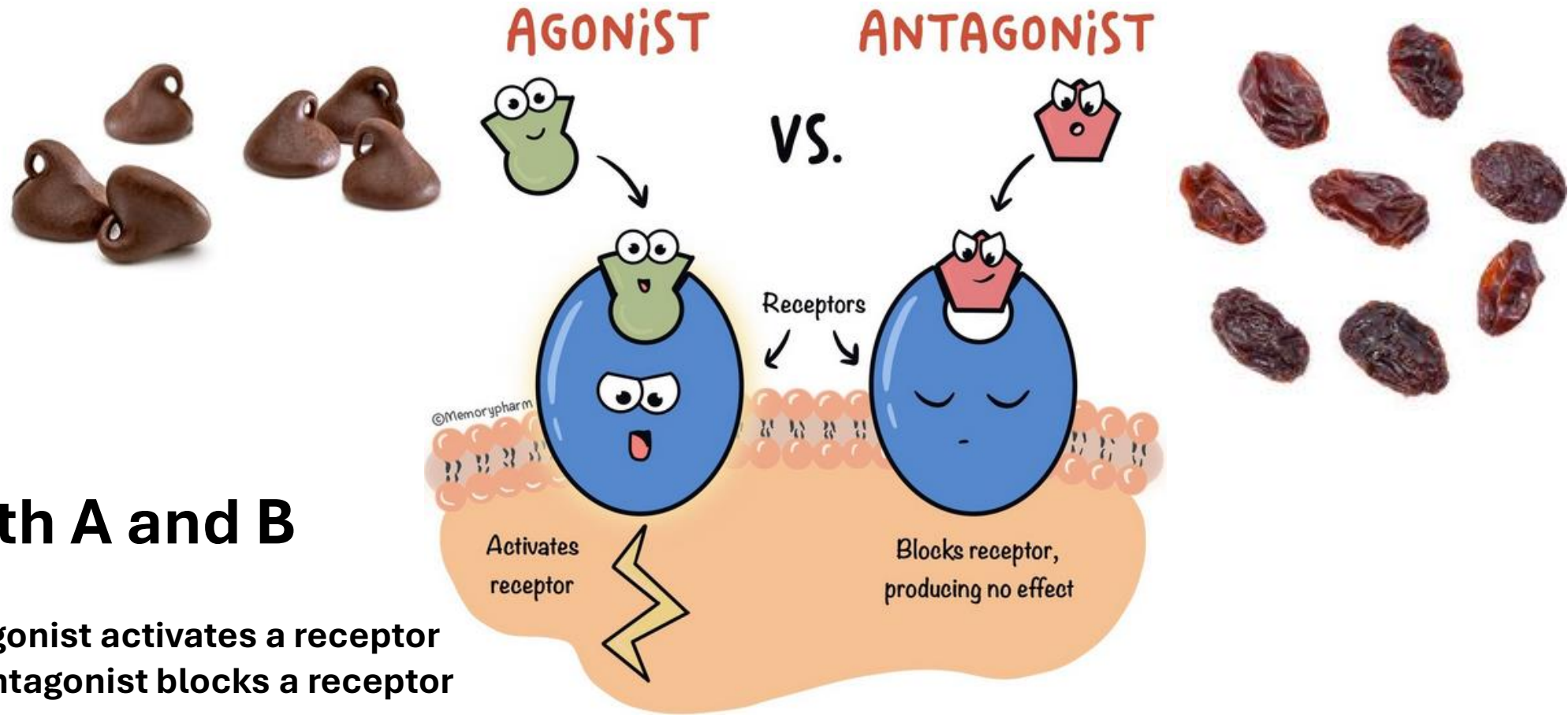

D. Both A and B

- A. An agonist activates a receptor
- B. An antagonist blocks a receptor

GLP-1R – What does it do?

Glucagon-like peptide-1

- Stimulates insulin
- Suppresses glucagon
- Slows digestion
- Increases satiety

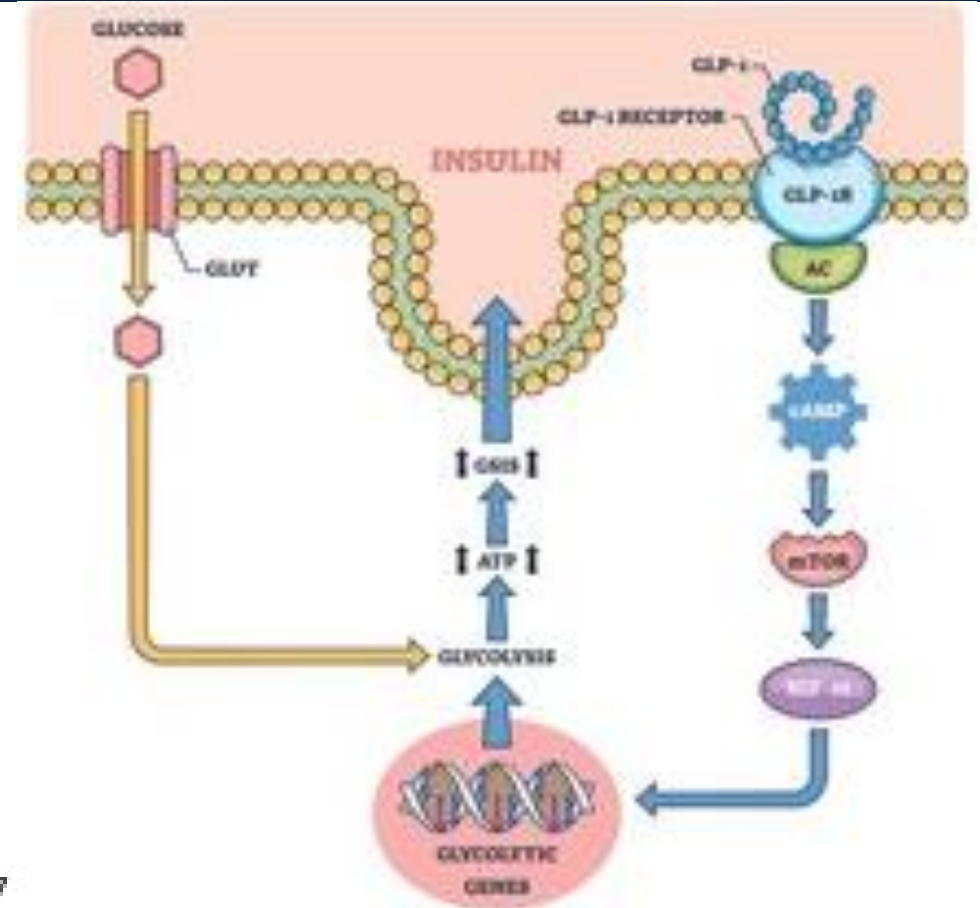

shutterstock.com · 2522255417

2026 ISPE-Midwest Tech Ed
Symposium & Vendor Showcase

Tuesday, May 19
Overland Park Convention
Center

The Rise of GLP-1s

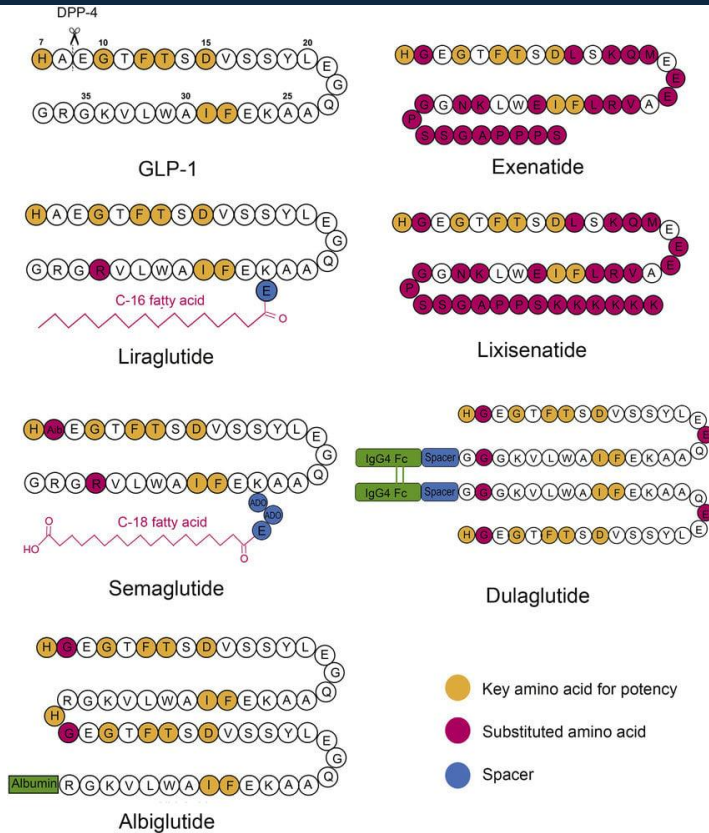

Battle of GLP-1 delivery technologies - Scientific Figure on ResearchGate. Available from: https://www.researchgate.net/figure/Peptide-sequences-and-molecular-structures-of-FDA-approved-GLP-1-RAs_fig1_326447155 [accessed 11 May 2026]

2026 ISPE-Midwest Tech Ed Symposium & Vendor Showcase

Tuesday, May 19
Overland Park Convention
Center

The Rise of GLP1-RAs

Drug	Brand Name	Indication	Form	FDA Approval
Liraglutide	Victoza	Type 2 diabetes	Injectable	2010
Liraglutide	Saxenda	Weight loss	Injectable	2014
Semaglutide	Ozempic	Type 2 diabetes	Injectable	2017
Semaglutide	Wegovy	Weight loss	Injectable	2021
Tirzepatide	Mounjaro	Type 2 diabetes	Injectable	2022
Semaglutide	Rybelsus	Type 2 diabetes	Oral	2023
Tirzepatide	Zepbound	Weight loss	Injectable	2023
Retatrutide	TBD	Weight loss	Injectable	TBD
Orforglipron	TBD	Weight loss	Oral	TBD

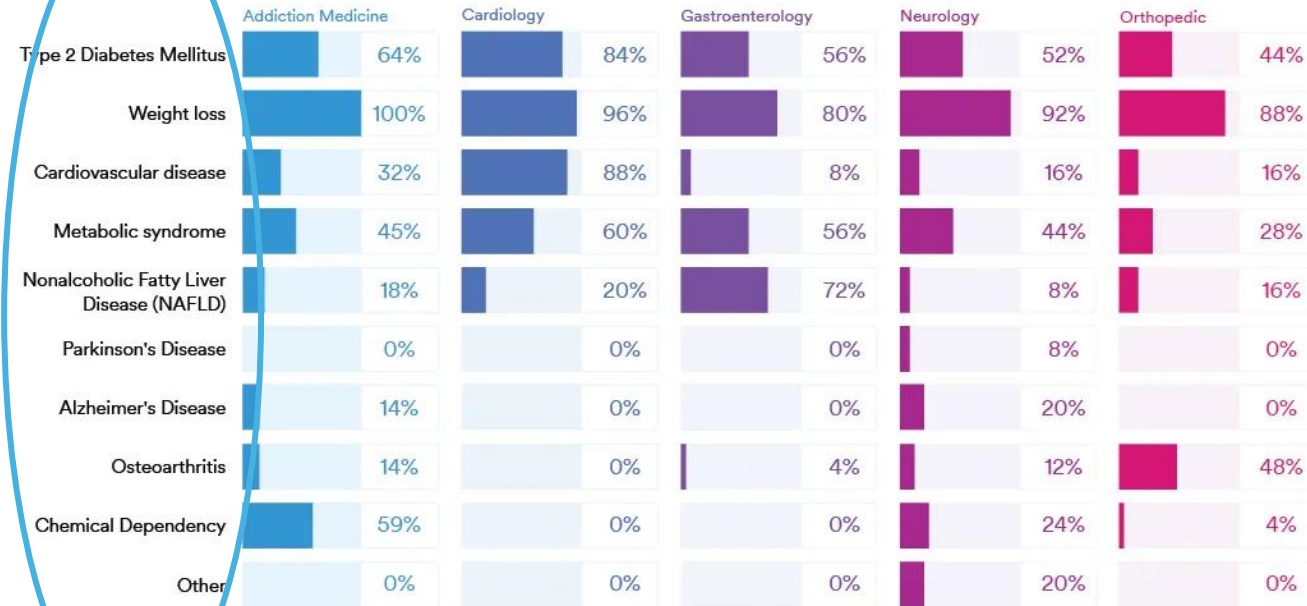
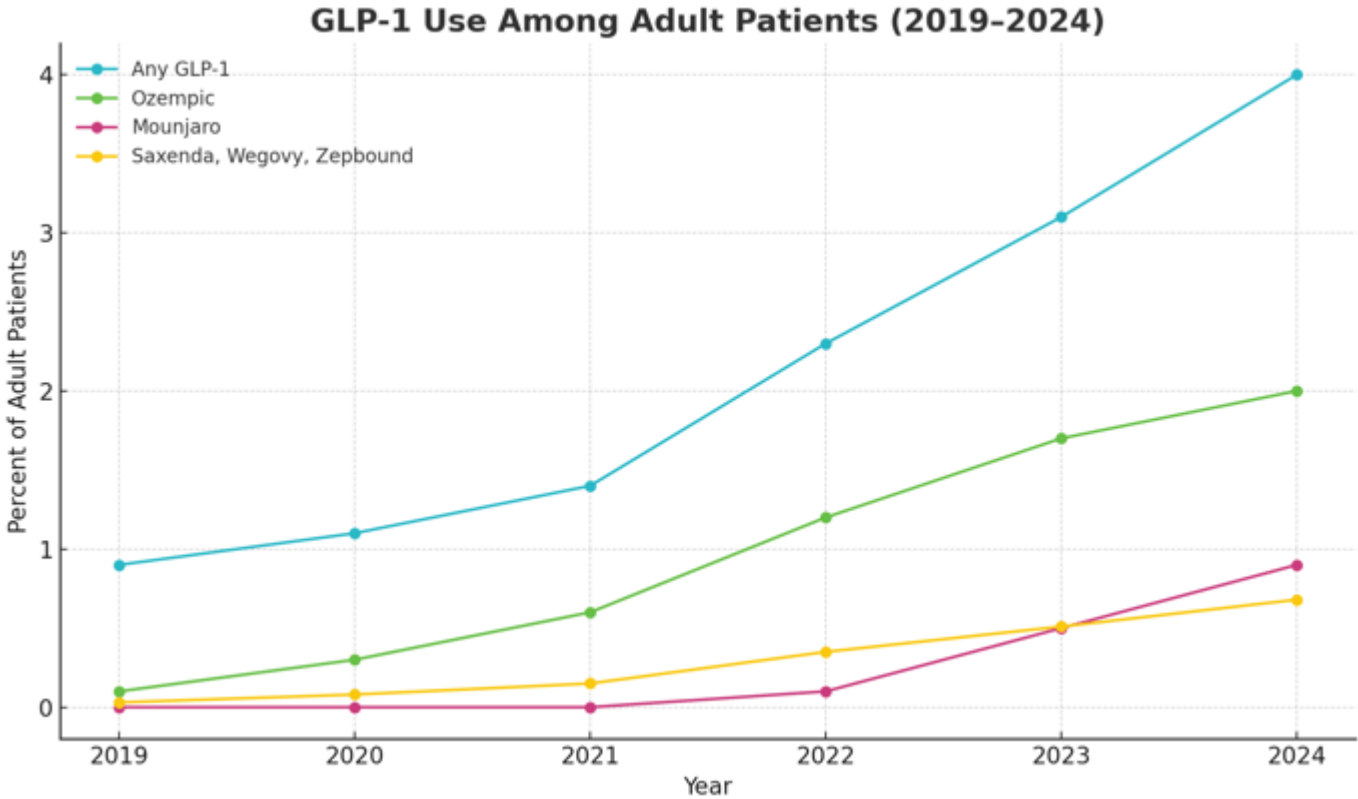

Fig 5. In which conditions have you prescribed GLP-1RAs?

2026 ISPE-Midwest Tech Ed
Symposium & Vendor Showcase

Tuesday, May 19
Overland Park Convention
Center

GLP-1RA – What’s the big deal?



GLP-1 trends since 2019, created using data from FAIR Health study.

2026 ISPE-Midwest Tech Ed
Symposium & Vendor Showcase

Tuesday, May 19
Overland Park Convention
Center

GLP-1RA – What's the problem?

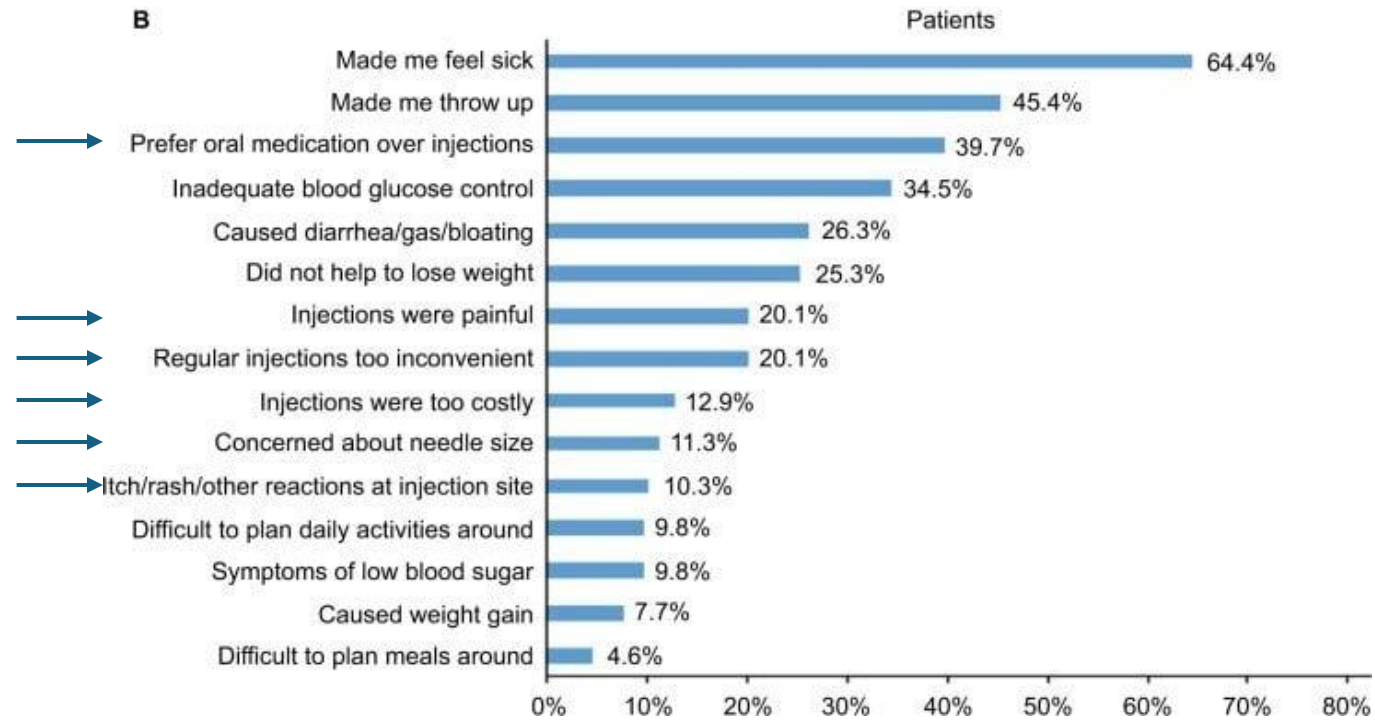
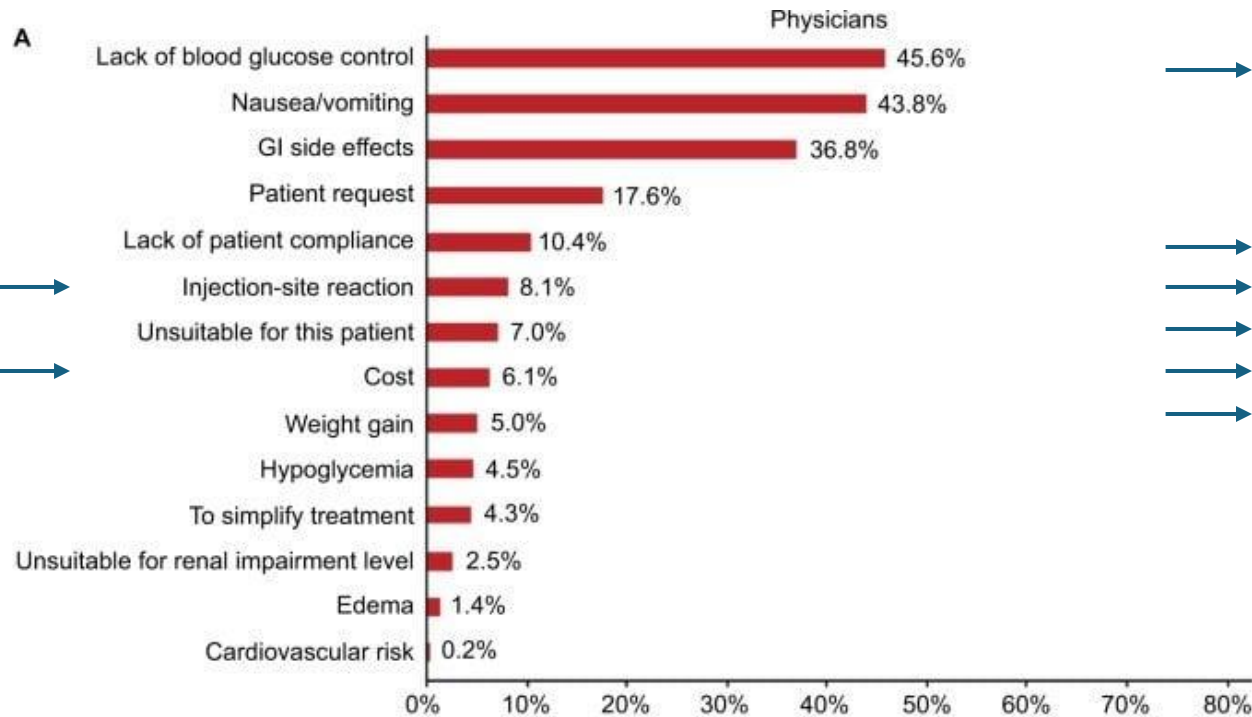

Sikirica, Mirko & Martin, Alan & Wood, Robert & Leith, Andrea & Piercy, James & Higgins, Victoria. (2017). Reasons for discontinuation of GLP1 receptor agonists: data from a real-world cross-sectional survey of physicians and their patients with type 2 diabetes.

2026 ISPE-Midwest Tech Ed
Symposium & Vendor Showcase

Tuesday, May 19

Overland Park Convention
Center

The Oral GLP-1RA Moment

Injectables (prefilled syringe/autoinjector): \$2 – \$15+ per unit



Tablets: \$0.01 – \$0.50 per unit



Best Place to Inject Ozempic (Semaglutide)

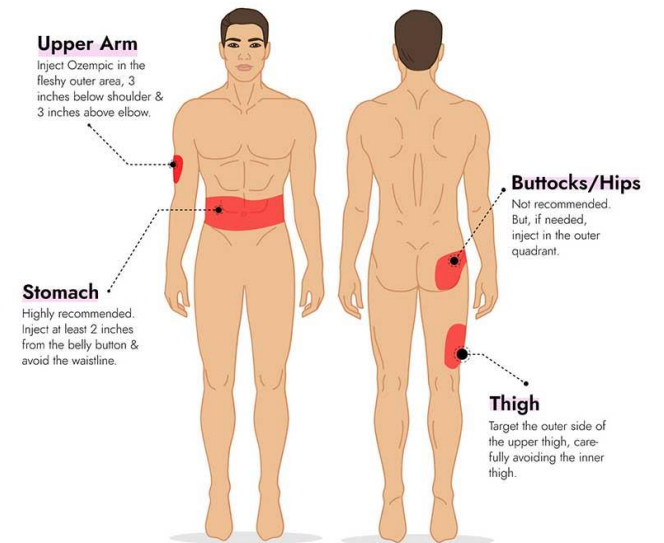

*Rotating injection sites helps prevent skin irritation & ensures consistent absorption.

2026 ISPE-Midwest Tech Ed
Symposium & Vendor Showcase

Tuesday, May 19
Overland Park Convention
Center

The Oral GLP-1RA Moment

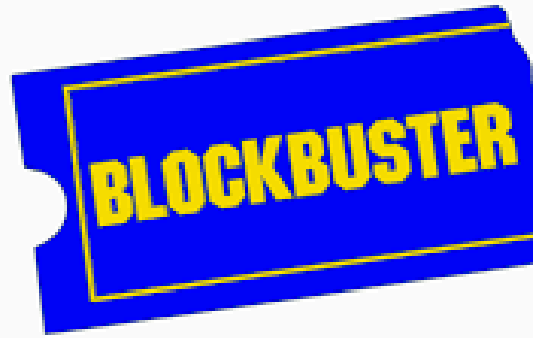
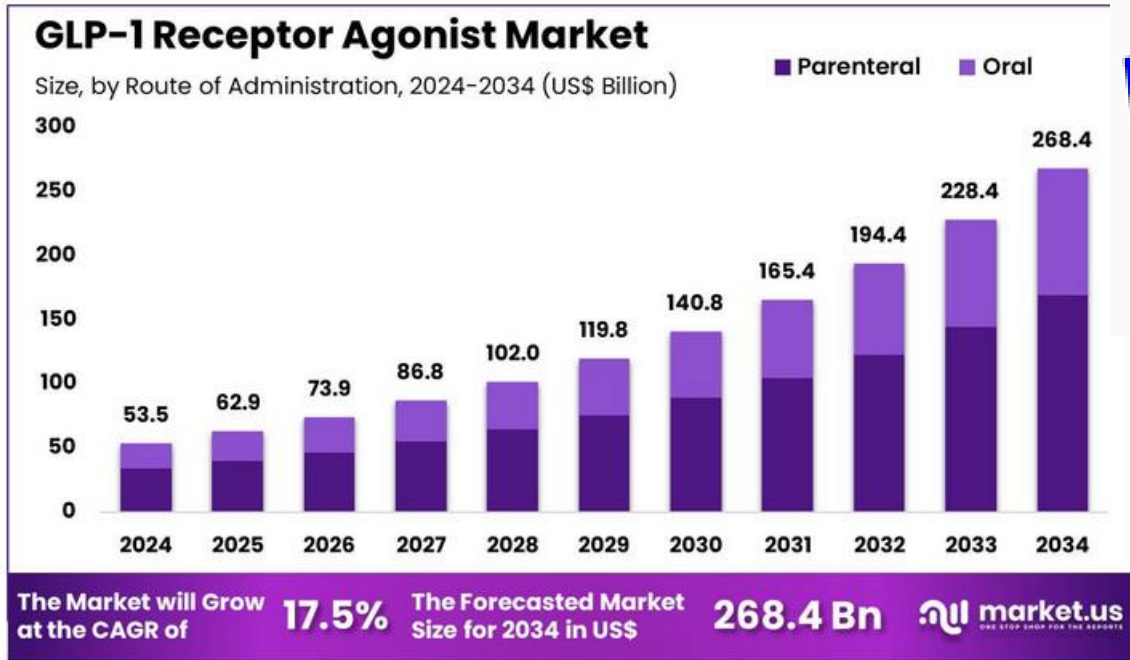

Oral GLP-1 Market Size 2025 to 2035 (USD Billion)

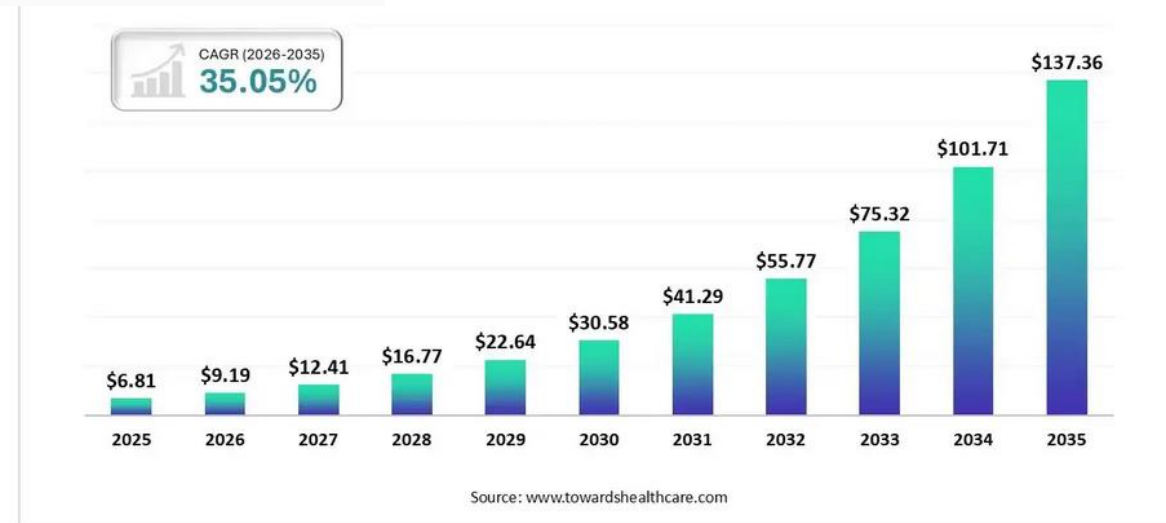

pah-REN-ter-al

2026 ISPE-Midwest Tech Ed
Symposium & Vendor Showcase

Tuesday, May 19
Overland Park Convention
Center

The Oral GLP-1RA Moment

2 commercially available — April 2026

3+ programs entering Phase 3 in 2026

Oral Zero to 5 in 18 months

Injectable 10 years



That's not a wave; that's a tsunami

2026 ISPE-Midwest Tech Ed
Symposium & Vendor Showcase

Tuesday, May 19
Overland Park Convention
Center

Oral GLP-1RA Pipeline at a Glance

Company	Drug	Status	Weight Loss	Timeframe
Novo Nordisk	Wegovy pill	Approved	16.6%	64 wks
Eli Lilly	Foundayo (orforglipron)	Approved	12.4%	72 wks
Viking Therapeutics	VK2735 oral	Phase 3 Q3	12.2%	13 wks*
AstraZeneca	Elecoglipron	Phase 3	NR	Ph2 complete
Roche / Genentech	CT-996	Phase 2	7.3%	4 wks*

**Data from earlier trial timepoints. AstraZeneca WL data not yet disclosed. Pfizer (danuglipron) exited this space in 2024.*



2026 ISPE-Midwest Tech Ed Symposium & Vendor Showcase

Tuesday, May 19
Overland Park Convention
Center

Semaglutide peptide

seh-mah-GLOO-tide

Rybelsus

RY-bel-sus

Wegovy

wee-GOH-vee

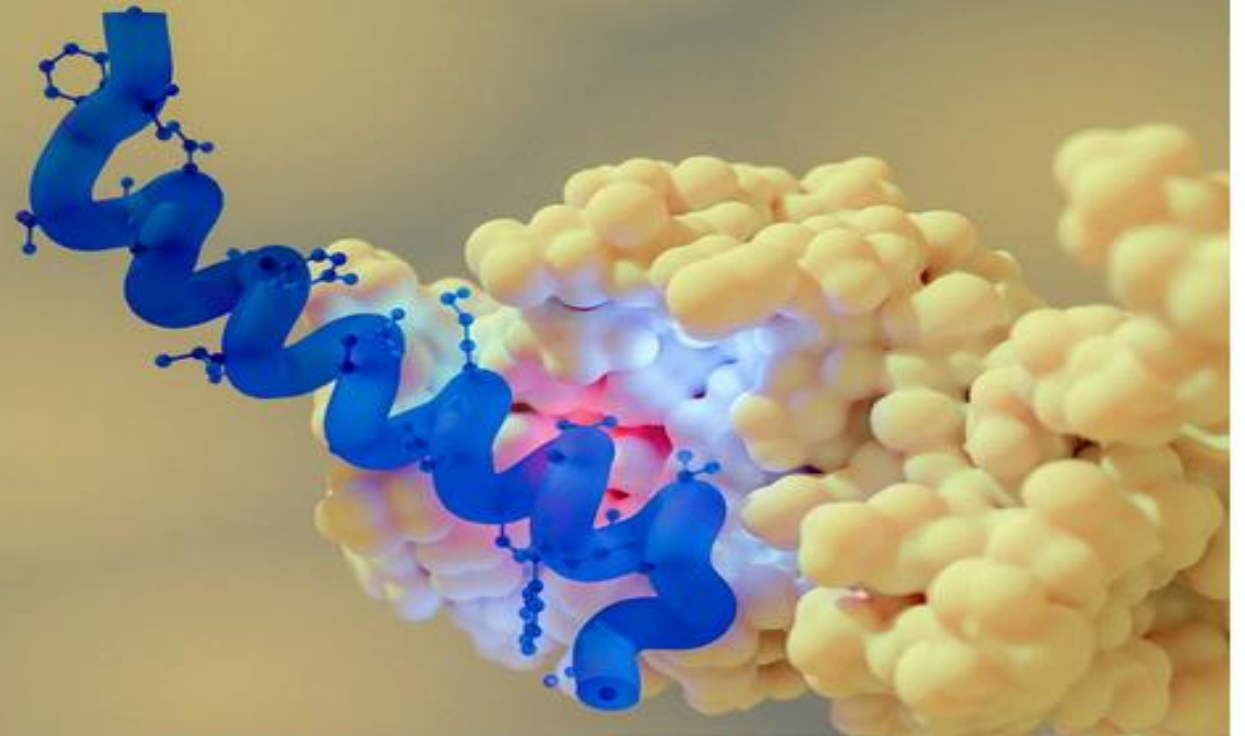

Semaglutide peptide (blue) bound to its target glucagon-like peptide-1 (GLP-1, light pink). Photo by Getty Images.

2026 ISPE-Midwest Tech Ed
Symposium & Vendor Showcase

Tuesday, May 19
Overland Park Convention
Center

Wegovy pill (semaglutide 25mg) | Rybelsus | FDA Approved

Oral semaglutide — accurate tablet cross-section
Rybelsus (7 mg, 14 mg) · Wegovy pill (25 mg)

No enteric coat
Uncoated tablet —
dissolves in stomach

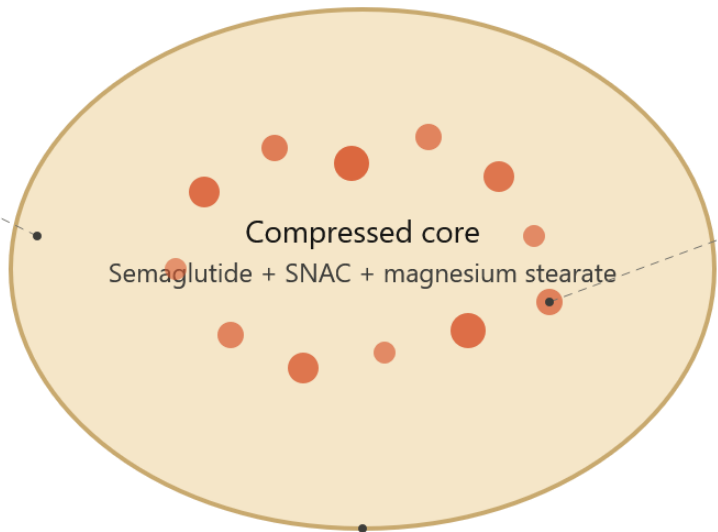

SNAC molecules
Co-formulated in core
Raise local gastric pH
Enhance epithelial permeability

Absorption: gastric mucosa · fasting required · ~1% bioavailability



2026 ISPE-Midwest Tech Ed Symposium & Vendor Showcase

Tuesday, May 19
Overland Park Convention
Center

Novo Nordisk's Wegovy pill is a semaglutide. What's the formulation difference between it and Rybelsus?

A. Higher batch consistency requirements for patient compliance labeling

B. Enteric coating uniformity to protect SNAC

C. Higher dose of semaglutide

D. Chocolate coating helps it go down easier



Peptide vs Small Molecule

1. Small Molecule Drugs

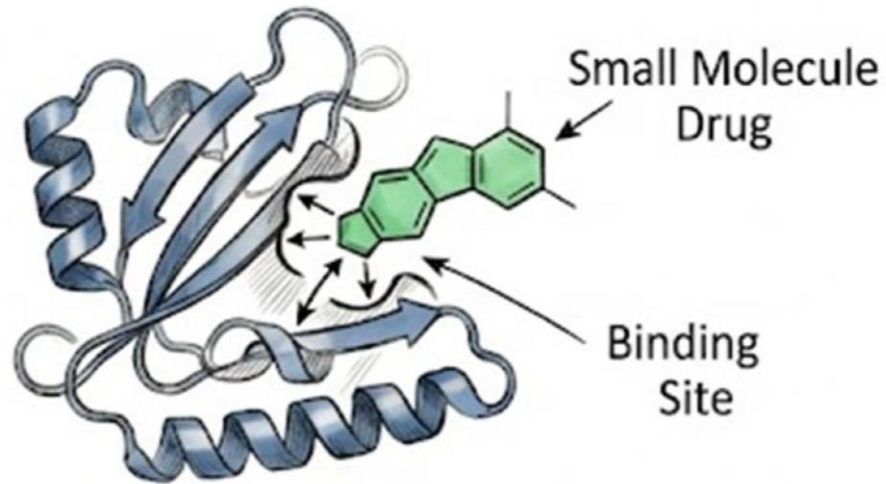

Bind to Well-Defined Binding Sites

2. Peptide Drugs (Large Pockets)

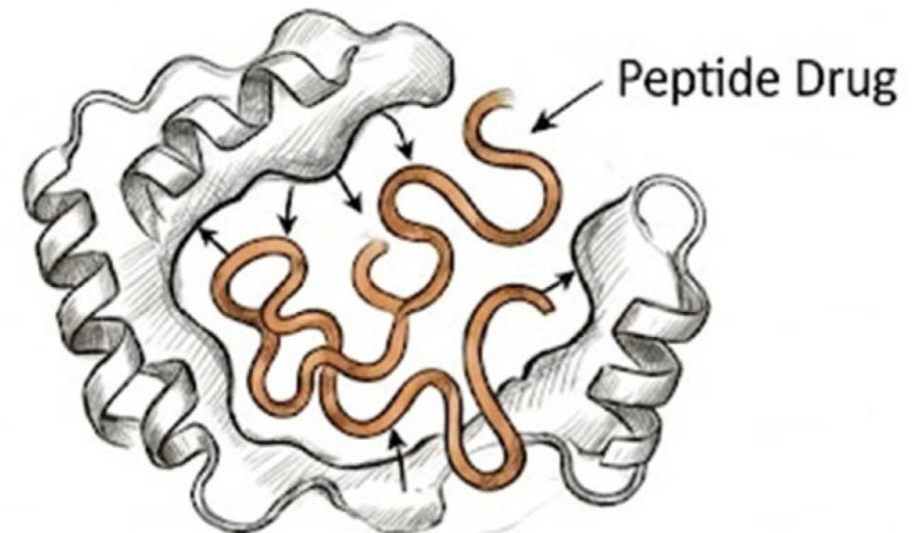

Occupy Large, Special Pockets

Lin, H.; Vogel, H.; Zhang, H. A Comparative Review of Artificial Intelligence Applications in Small Molecule Versus Peptide Drug Discovery. *Int. J. Mol. Sci.* **2026**, *27*, 3142. <https://doi.org/10.3390/ijms27073142>

2026 ISPE-Midwest Tech Ed
Symposium & Vendor Showcase

Tuesday, May 19
Overland Park Convention
Center

Foundayo (orforglipron) | FDA approved April 1, 2026

Foundayo (orforglipron) — accurate tablet cross-section
Eli Lilly · FDA approved April 1, 2026 · 0.8 mg → 17.2 mg

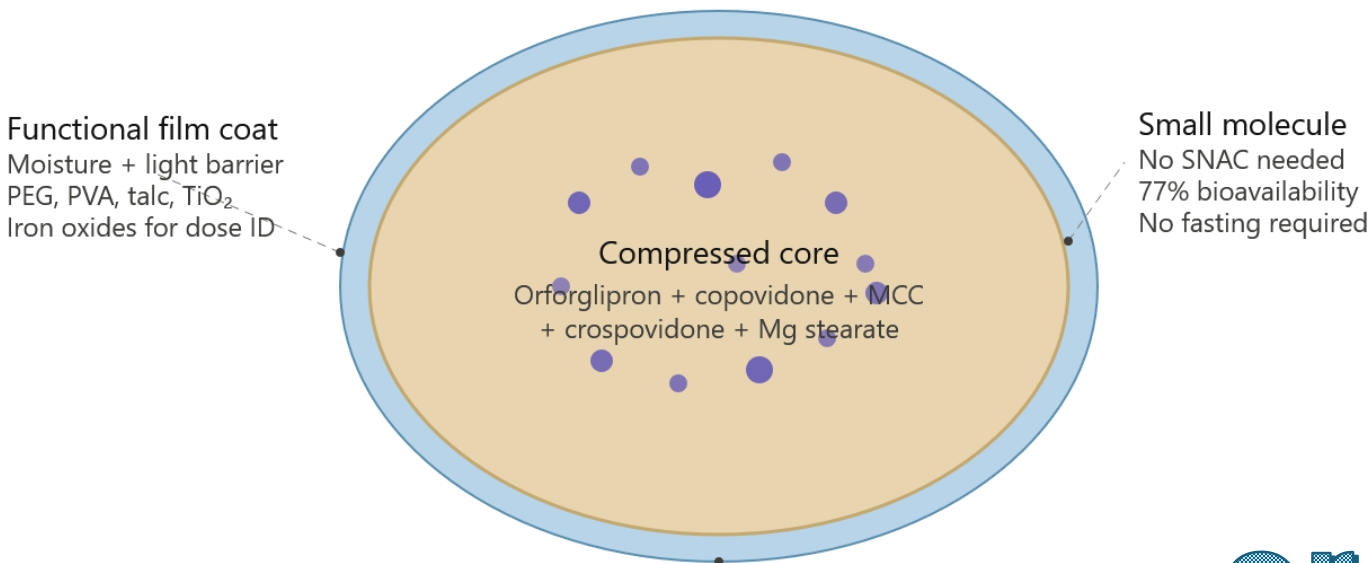

Absorption: small intestine · immediate release · with or without food

or-for-GLIP-ron

2026 ISPE-Midwest Tech Ed Symposium & Vendor Showcase

Tuesday, May 19
Overland Park Convention
Center

What we do know:

- Non-peptide small molecule
- Different binding geometry
- Phase 2 – end points met
 - VISTA - obesity
 - SOLSTICE - T2D



el-EE-co-GLIP-ron

2026 ISPE-Midwest Tech Ed
Symposium & Vendor Showcase

Tuesday, May 19
Overland Park Convention
Center

Dual GLP1-RA plus GIP-RA

Lilly's injectable – tirzepatide

- Mounjaro – T2D
- Zepbound – obesity

tir-ZEP-a-tide
moon-JAR-oh

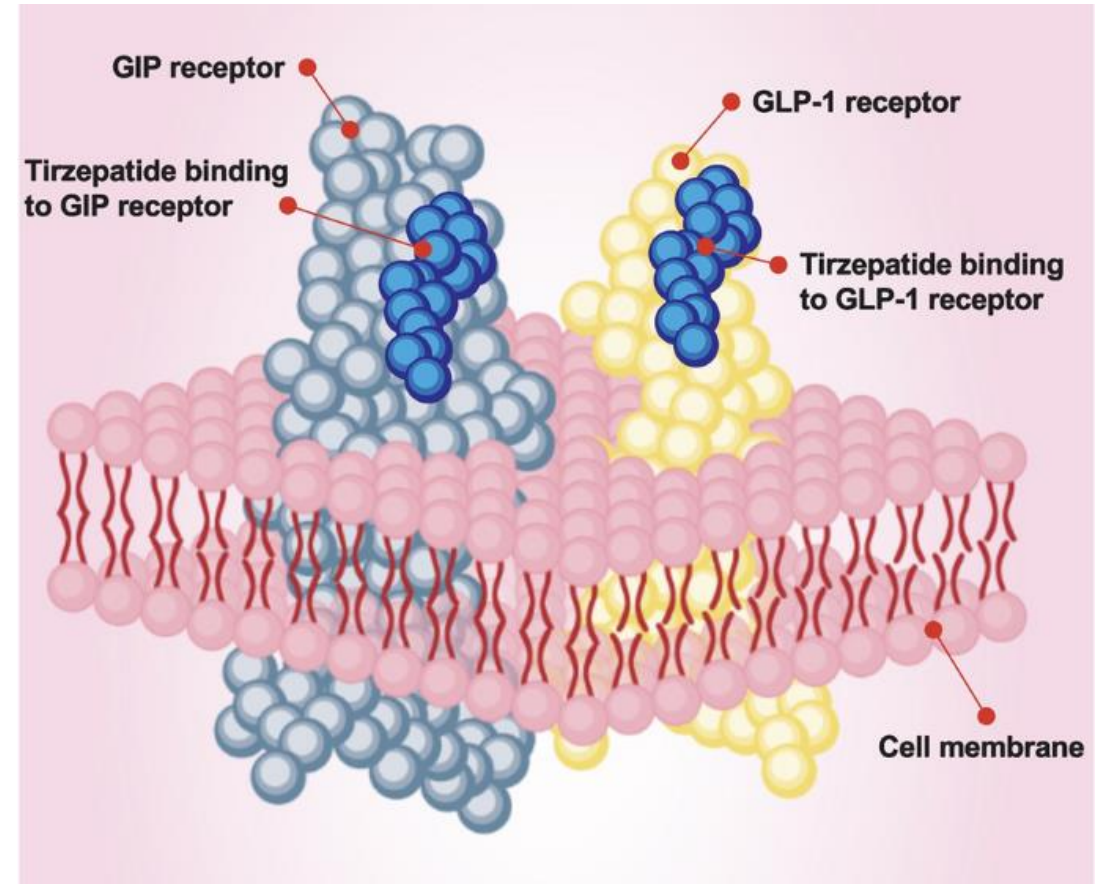

2026 ISPE-Midwest Tech Ed
Symposium & Vendor Showcase

Tuesday, May 19
Overland Park Convention
Center

What we do know:

- Dual mechanism like tirzepatide, but it is Viking's molecule
- GLP1-RA plus GIP-RA
- What's the problem in P2?
 - Discontinuation due to nausea
- Fix?
 - Slower titration
 - Lower starting dose
 - Longer step-up windows



2026 ISPE-Midwest Tech Ed
Symposium & Vendor Showcase

Tuesday, May 19
Overland Park Convention
Center

What coating strategy **could** Viking use to manage GI tolerability in oral VK2735?

A. Include a SNACK – like cupcakes

B. Modified release coating – slow drug release, flattens Cmax

C. Enteric coating – bypass the stomach entirely

D. No coating – uncoated compressed core

GLP-1RA

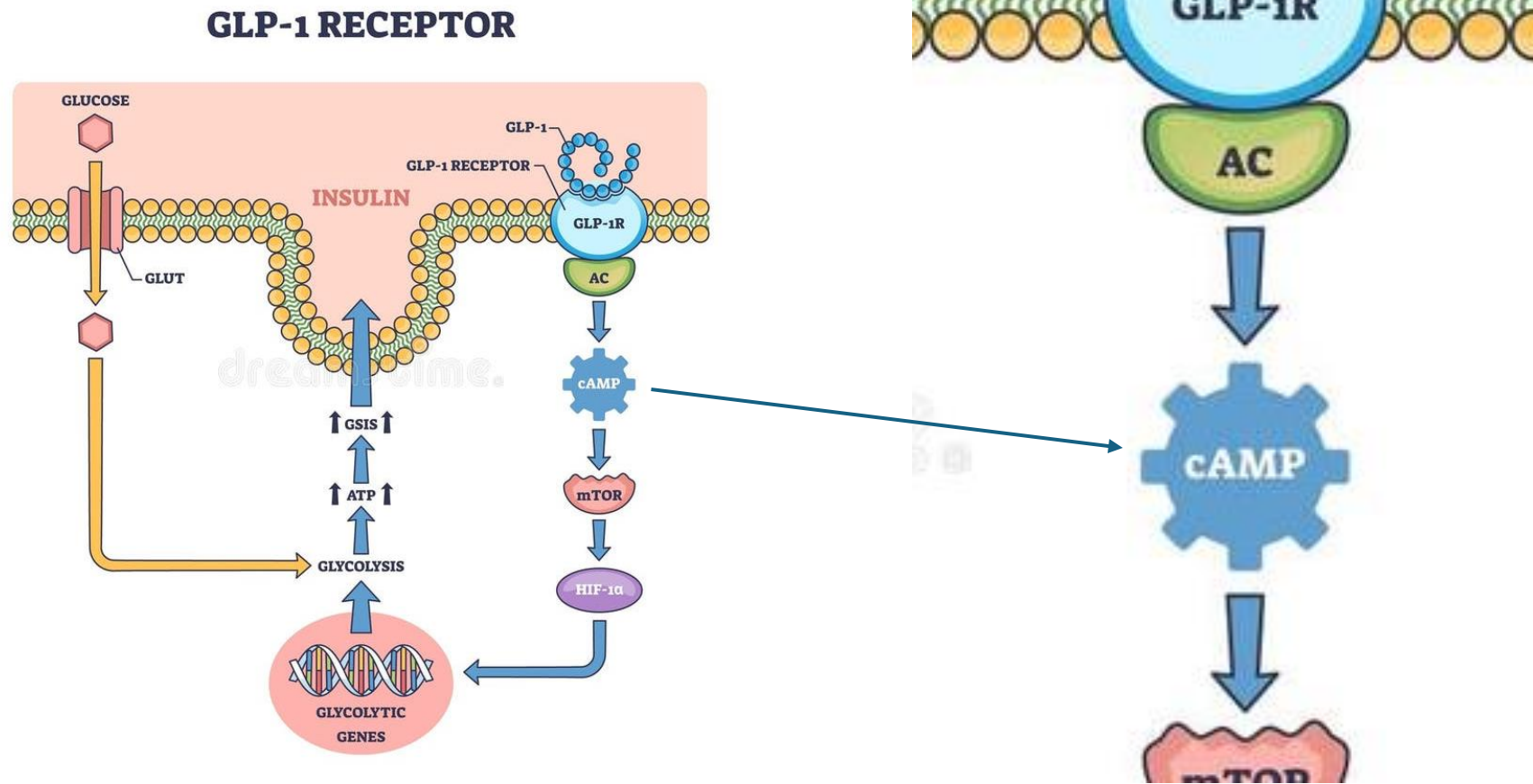

2026 ISPE-Midwest Tech Ed
Symposium & Vendor Showcase

Tuesday, May 19
Overland Park Convention
Center

CT-996 | Biased small molecule GLP-1 agonist

Biased GLP-1 Receptor Agonism

Roche CT-996 · cAMP pathway only · β -arrestin recruitment blocked

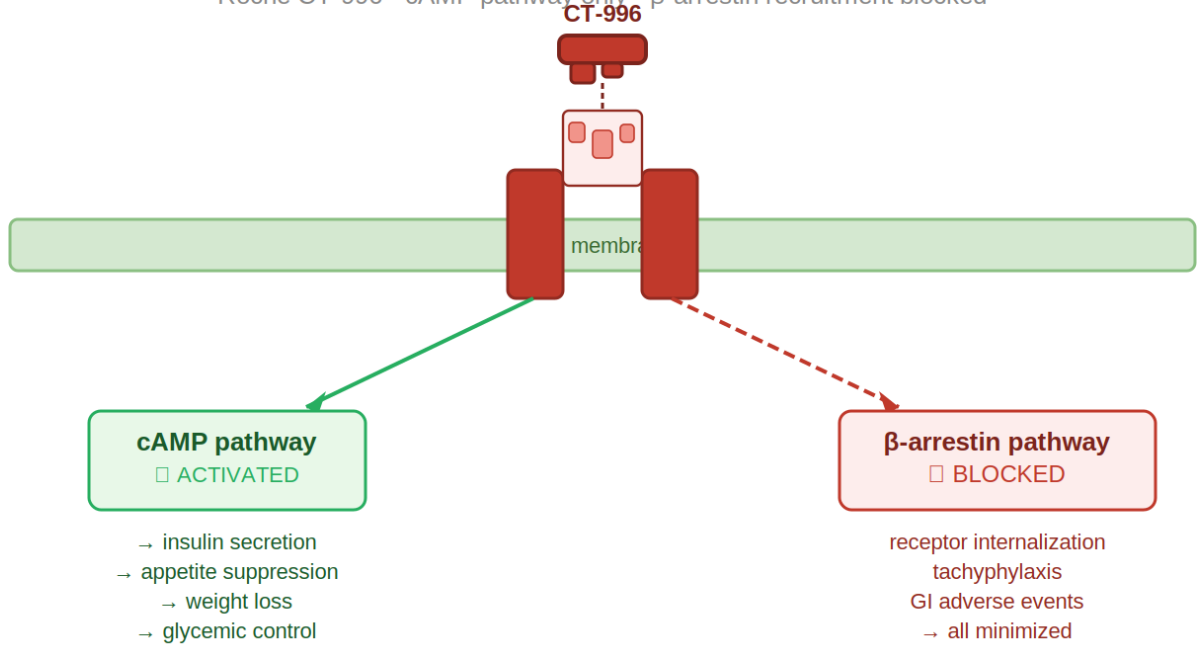

Biased agonism = all the efficacy, less of the side effects · the next frontier in GLP-1 design

What we do know:

- No discontinuations due to AEs in Ph1
- P2 – no results yet



2026 ISPE-Midwest Tech Ed Symposium & Vendor Showcase

Tuesday, May 19
Overland Park Convention
Center

Future – What about Granulation?

- High Shear Wet Granulation
- Fluid Bed Granulation
- Single Pot Granulation with VAGAS
- Continuous Granulation

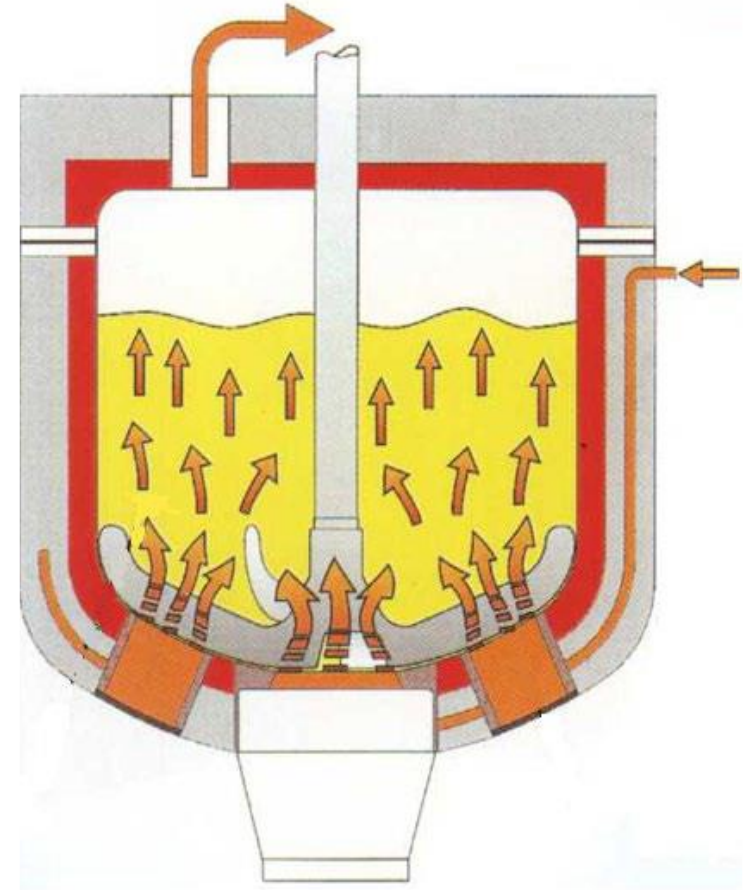

2026 ISPE-Midwest Tech Ed
Symposium & Vendor Showcase

Tuesday, May 19

Overland Park Convention Center

Future – Eli Lilly – Retatrutide (LY3437943) Injectable

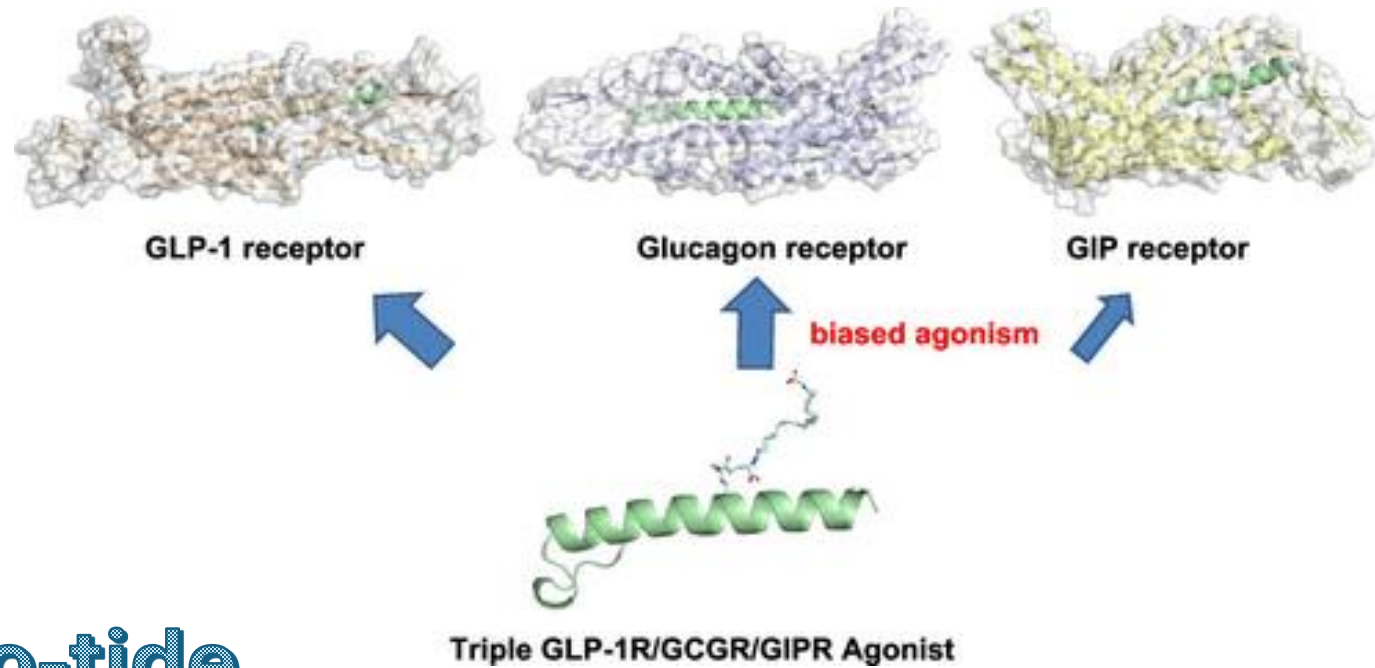

reh-TAT-roo-tide



2026 ISPE-Midwest Tech Ed
Symposium & Vendor Showcase

Tuesday, May 19
Overland Park Convention Center

Dry Powder Processing Equipment



WEIGHING



**MILLING &
SIEVING**



**TABLET
COATING**



HANDLING

GRANULATION



BLENDING



CONTINUOUS



2026 ISPE-Midwest Tech Ed
Symposium & Vendor Showcase

Tuesday, May 19
Overland Park Convention
Center

Tablet Types

TYPES OF TABLET



CONVENTIONAL



ODT



COATED

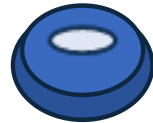

SUBLINGUAL



BUCCAL



CHEWABLE



CONTROLLED
RELEASE

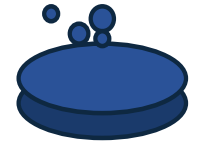

EFFERVESCENT

2026 ISPE-Midwest Tech Ed
Symposium & Vendor Showcase

Tuesday, May 19

Overland Park Convention
Center

History of Coating Types

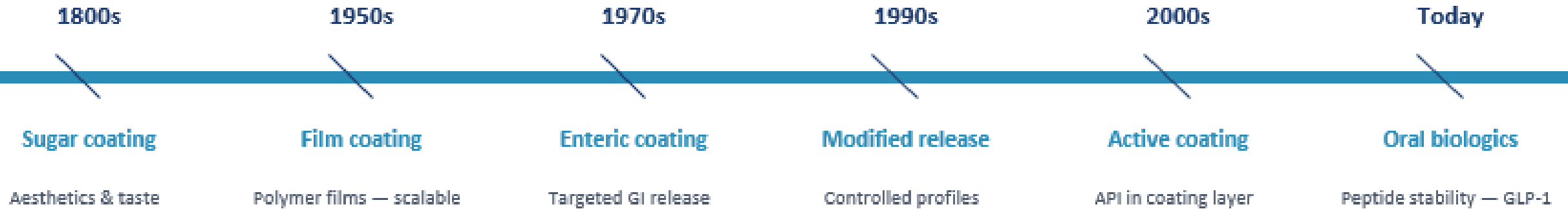

2026 ISPE-Midwest Tech Ed
Symposium & Vendor Showcase

Tuesday, May 19
Overland Park Convention
Center

Film Coating

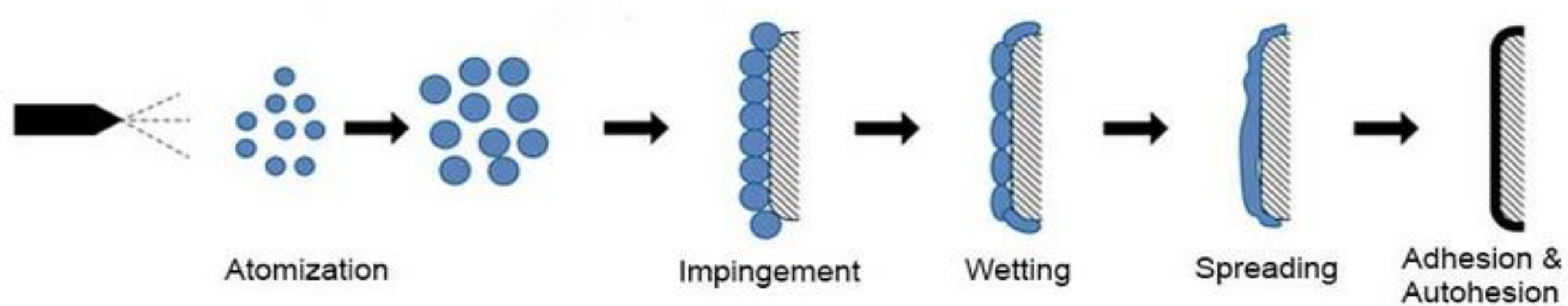

2026 ISPE-Midwest Tech Ed
Symposium & Vendor Showcase

Tuesday, May 19
Overland Park Convention
Center

Film Coating

Cosmetic film coating

- Color
- Swallowability
- Brand identity
- Taste masking



Functional film coating

- Enteric coating
- Modified/controlled release
- Active coating
- Barrier



2026 ISPE-Midwest Tech Ed
Symposium & Vendor Showcase

Tuesday, May 19
Overland Park Convention
Center

Coating Quality



0.14% weight gain



0.29% weight gain



0.45% weight gain



0.75% weight gain



1.56% weight gain



2.42% weight gain

2026 ISPE-Midwest Tech Ed
Symposium & Vendor Showcase

Tuesday, May 19
Overland Park Convention
Center

What is RSD?

A. Rasperry Swirl Donuts

B. Relative Standard Deviation

C. Rum-Soaked Dates

D. Residual Solvent Detection



Relative Standard Deviation

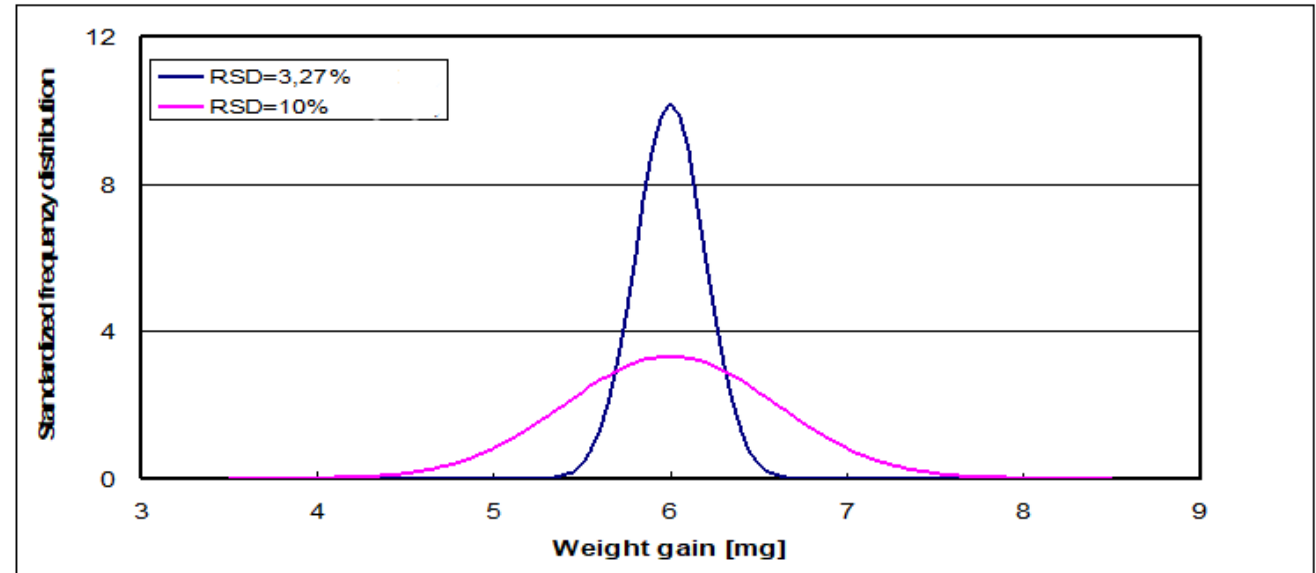
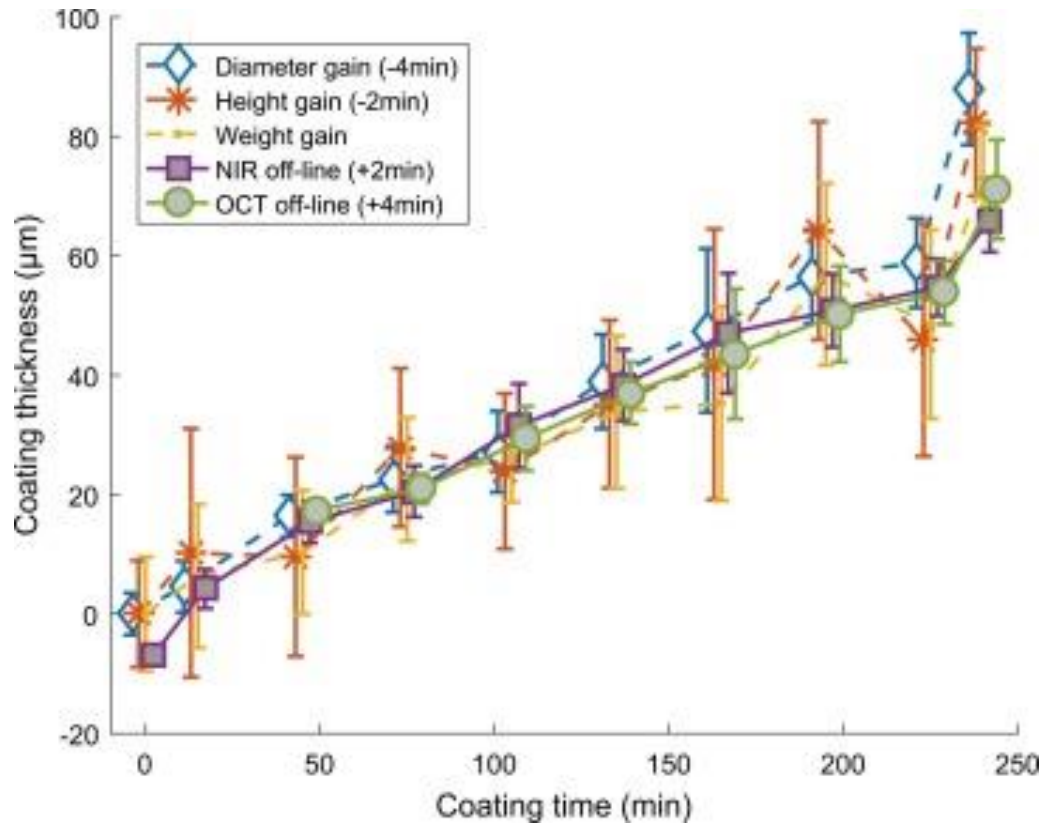

Example: Weight gain distribution

2026 ISPE-Midwest Tech Ed
Symposium & Vendor Showcase

Tuesday, May 19
Overland Park Convention
Center

Is it better to have high or low RSD when discussing tablet coatings?

- A. It depends
- B. Low – minimal deviation from tab to tab
- C. Trick question – RSD doesn't matter in tab coatings
- D. High – high standards from tab to tab

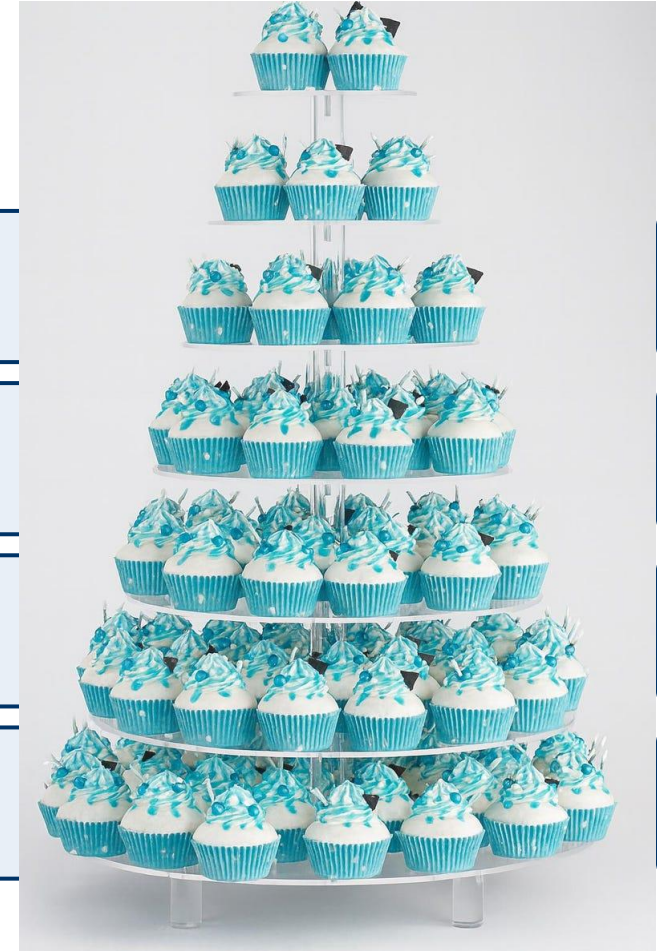

Coating Equipment

Factors

- Drum Shape
- Air flow
- Mixing baffles



2026 ISPE-Midwest Tech Ed
Symposium & Vendor Showcase

Tuesday, May 19
Overland Park Convention
Center

Drum Shape

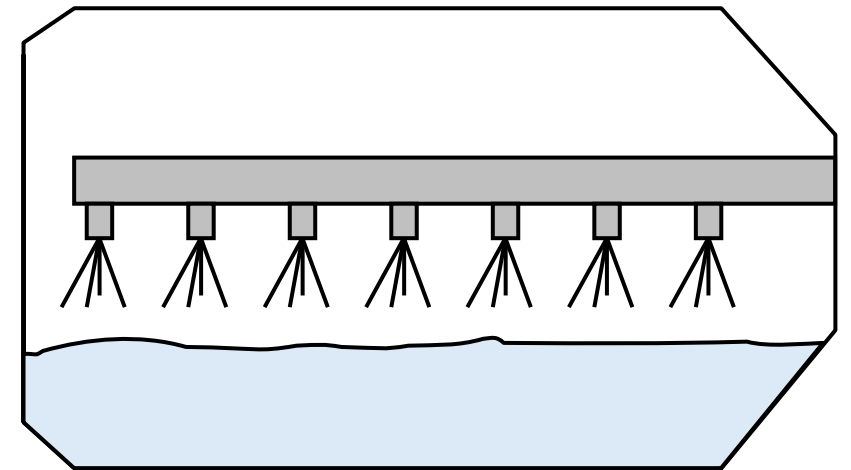
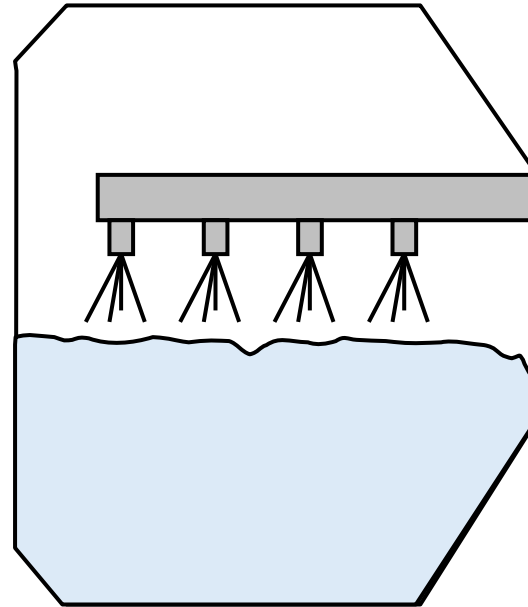

2026 ISPE-Midwest Tech Ed
Symposium & Vendor Showcase

Tuesday, May 19
Overland Park Convention
Center

Airflow

What is the spray drying effect?

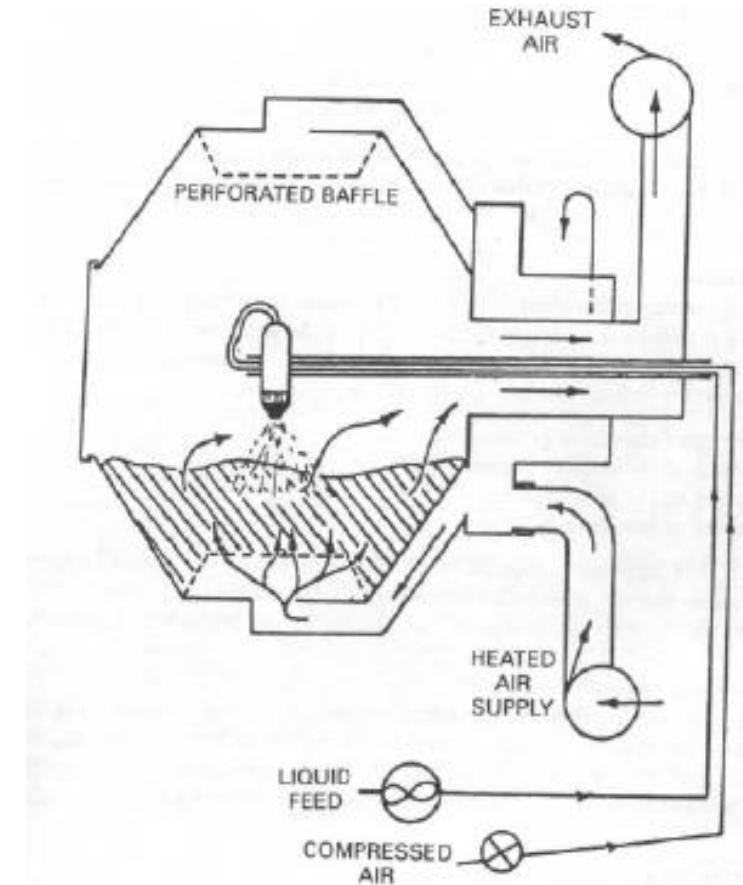
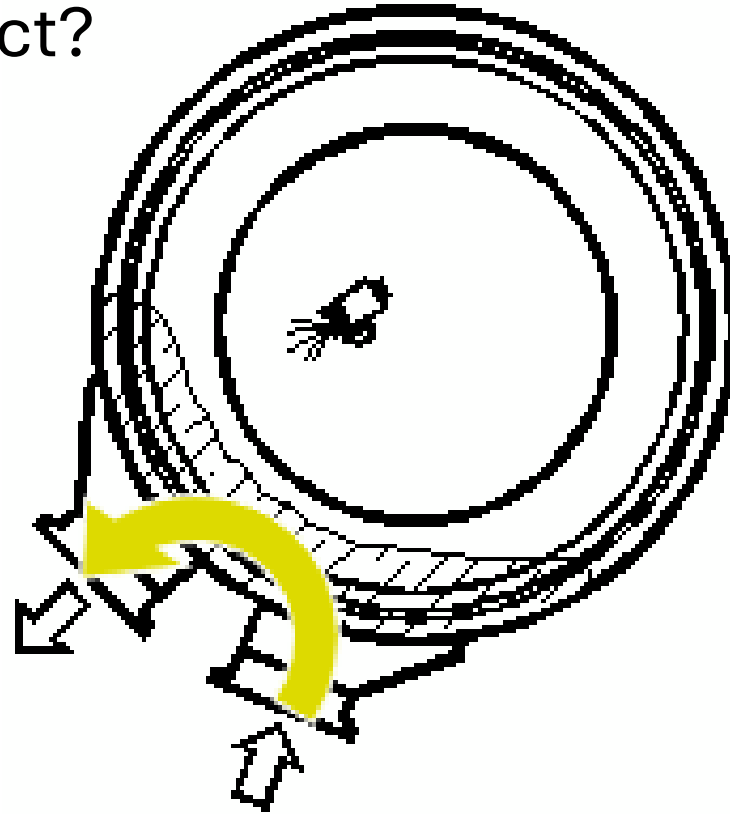
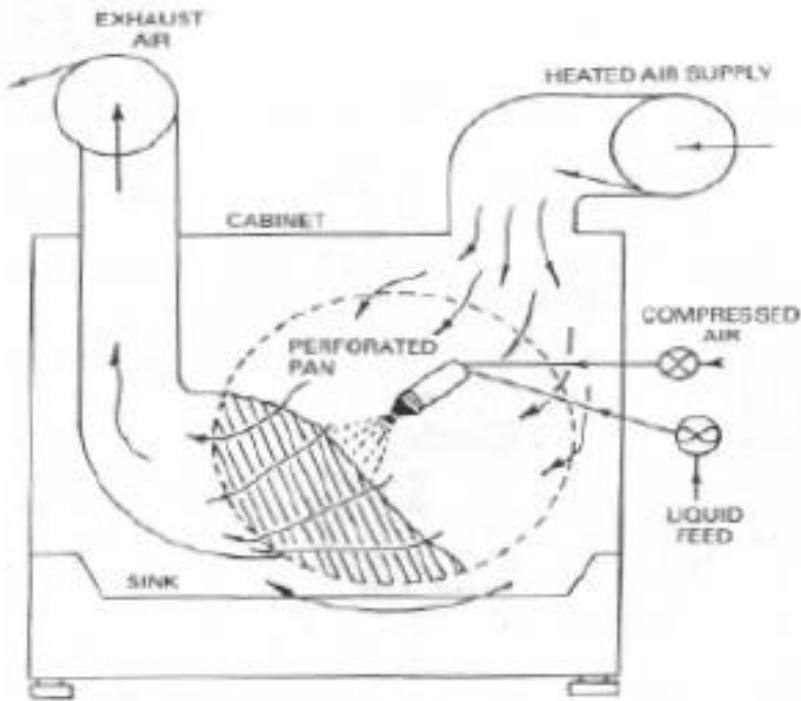

2026 ISPE-Midwest Tech Ed
Symposium & Vendor Showcase

Tuesday, May 19
Overland Park Convention
Center

Mixing Baffles

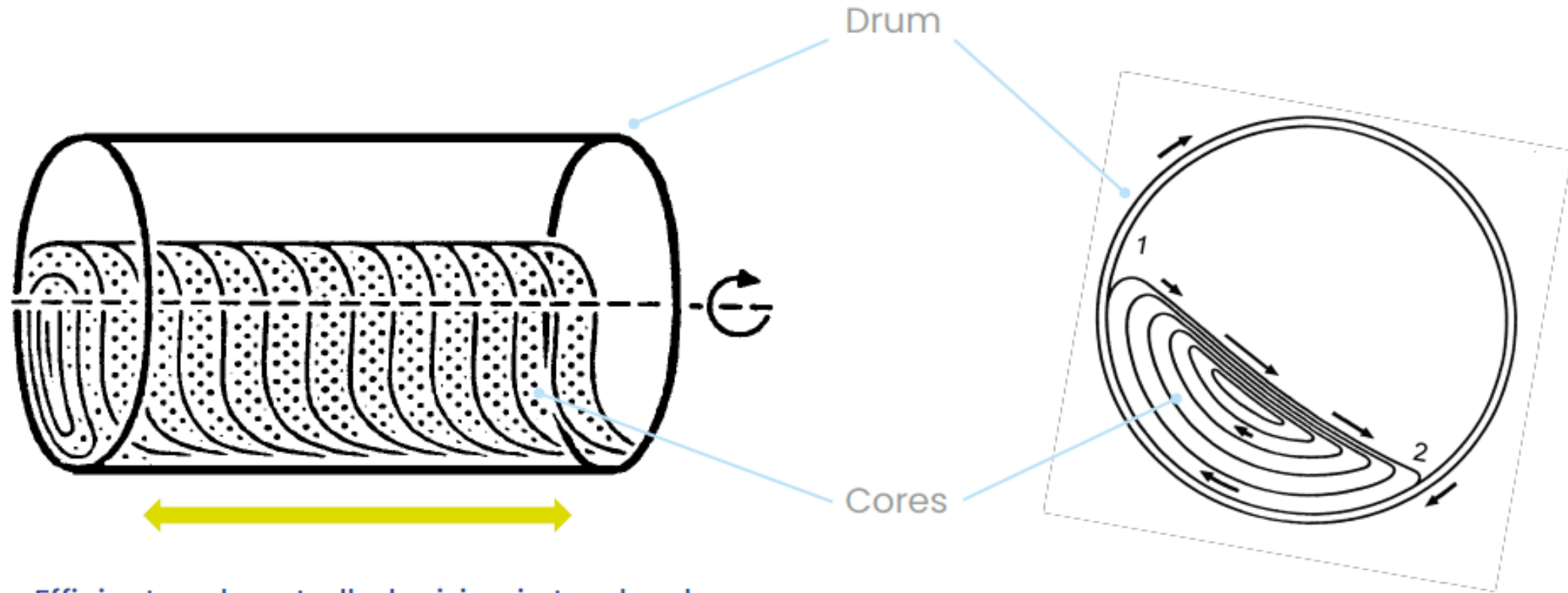

Efficient and controlled mixing in two levels
additional even horizontal mixing

2026 ISPE-Midwest Tech Ed
Symposium & Vendor Showcase

Tuesday, May 19
Overland Park Convention
Center

Mixing Baffles

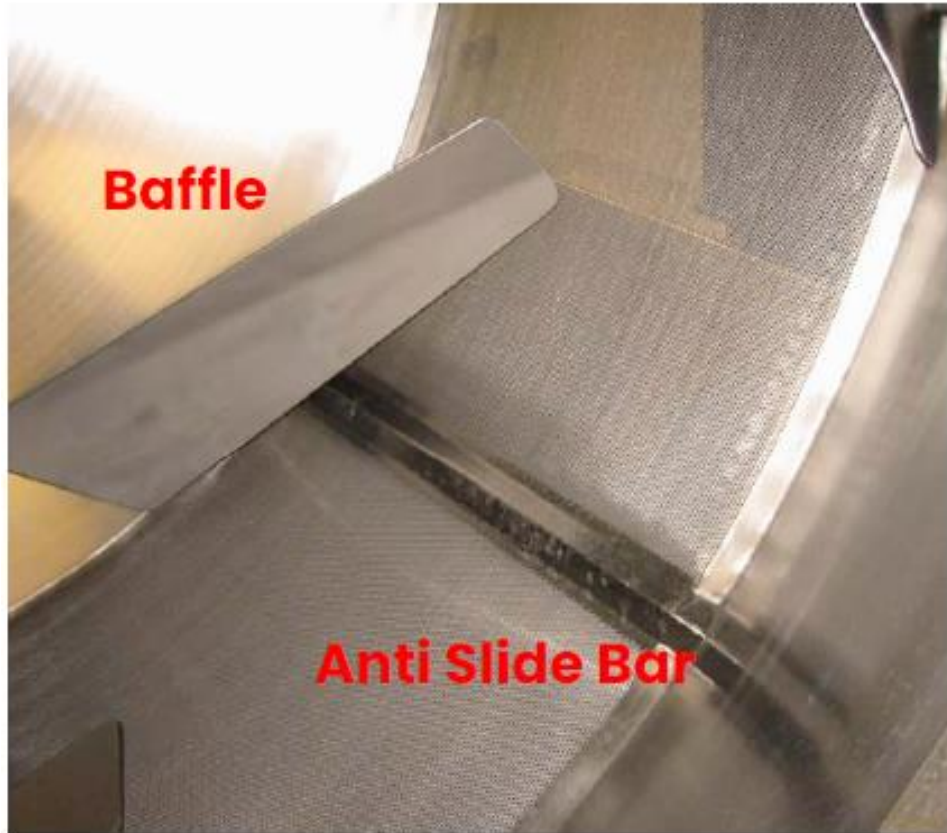

2026 ISPE-Midwest Tech Ed
Symposium & Vendor Showcase

Tuesday, May 19
Overland Park Convention
Center

Coating Equipment

Considerations

- **Coating Quality**
- **Process Flexibility**
- **Regulatory and Validation**
- **Economics and Operations**
- **Advanced/ Continuous Manufacturing**



2026 ISPE-Midwest Tech Ed
Symposium & Vendor Showcase

Tuesday, May 19
Overland Park Convention
Center

Continuous Coating Equipment

TABLET CORE RELAXATION TIME CONSIDERATIONS

Film coating immediately after compression can lead to film rupture

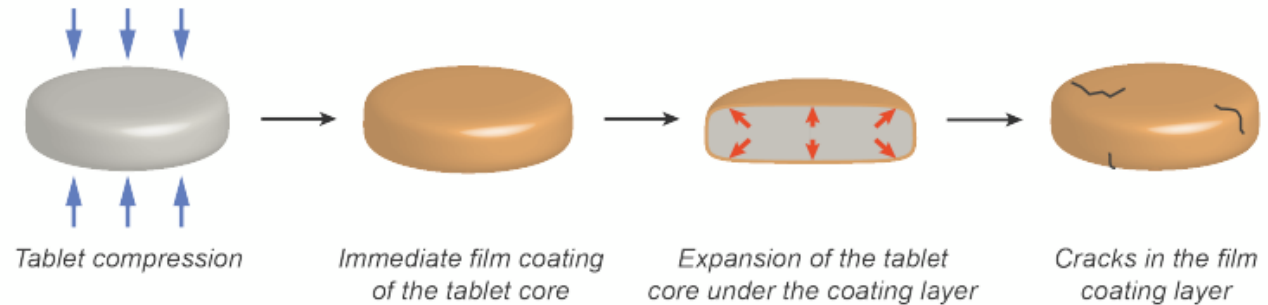

Storing of tablet cores between tableting and coating is advised

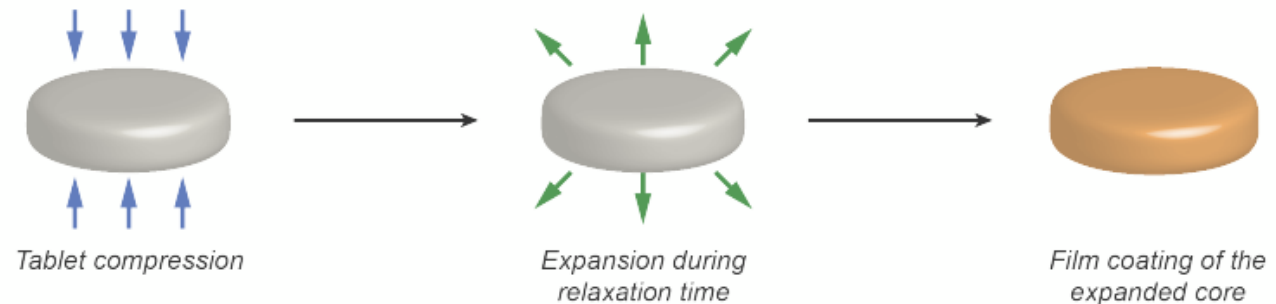

2026 ISPE-Midwest Tech Ed
Symposium & Vendor Showcase

Tuesday, May 19
Overland Park Convention
Center

Continuous Coating

How do you achieve a low RSD in a continuous coater?

A. It's impossible

B. Use a Continuous Batch Coater

C. I was promised dessert. Where's the dessert?

Tablet Coaters – Modern Line Up

company	R&D / lab scale	batch coater	continuous coater
L.B. Bohle	BFC 5 2-6 L	BFC 50 TriPan / BFC 100 / BFC 200 BFC 400 / BFC 600 7-980 L · high-end BTC 100 / BTC 200 / BTC 400 / BTC 600 economical workhorse	KOCO® Sequential batch — precision at throughput scale
Glatt	GC 500 / GC 750 Lab & pilot scale	GC 1000 / GC 1500 Production scale GCSmart® 125-700 L Enhanced controls, WIP	—
GEA	ConsiGma® FC (small) From 1.5 kg	ConsiGma® Film Coater Up to 500 kg / 8hr shift	ConsiGma® Film Coater Batch + continuous same unit Integrates into cont. OSD line
IMA / Thomas Processing <small>Thomas acq. by IMA 2021</small>	Accela-Cota® (small) Lab variants	Accela-Cota® Production perforated pan	FLEX CTC / ACCELA CTC 500 First continuous coater 1992 Up to 1,000 kg/h
Driam	Driacoat (small) Pilot scale	Driacoat Hollow-rib airflow system	Driacanti-T True continuous flow-through
O'Hara Technologies	Labcoat™ Lab / R&D	Fastcoat™ Production scale	—
Syntegon <small>formerly Bosch</small>	HKC (small) Lab / pilot	HKC series High-containment capable	—
ACG	—	SMARTCOATER X•ONE Launched 2023	—



Cute Bee Cake Pops?



Nailed it!

2026 ISPE-Midwest Tech Ed
Symposium & Vendor Showcase

Tuesday, May 19
Overland Park Convention
Center

Modern Line Up – Consideration Comparison

critierion	L.B. Bohle BFC	Glatt GC	GEA Solidcoat	Driam Driacoat	Thomas Accela-Cota	O'Hara Fastcoat	Bohle KOCO®	Thomas FLEX CTC
COATING QUALITY								
Coating uniformity (RSD)	✓✓	~	~	~	✗	✗	✓✓	✗
Enteric / functional coating	✓✓	✓	✓	✓✓	~	~	✓✓	~
Active coating (API in coat)	✓✓	~	✓	~	✗	✗	✓✓	✗
Heat-sensitive API protection	✓✓	~	~	~	✗	✗	✓✓	✗
Spray loss / efficiency	✓✓	~	~	✓	✗	✗	✓✓	~
PROCESS FLEXIBILITY								
Variable batch fill range	✓✓	~	✓	~	~	~	✓✓	✗
Scale-up consistency	✓✓	✓	✓	~	✓	~	✓✓	~
High throughput / continuous	~	~	✓	✓	✓✓	~	✓✓	✓✓
REGULATORY & VALIDATION								
FDA / EMA regulatory precedent	~	✓✓	✓	~	✓✓	✓	~	✓
PAT / real-time release ready	✓	~	✓✓	~	✓	✗	✓✓	✓
High containment (OEB 4/5)	✓✓	~	✓✓	~	✗	✗	✓✓	✗
ECONOMICS & OPERATIONS								
Capital cost	\$\$\$\$	\$\$\$	\$\$\$\$	\$\$\$	\$\$	\$\$	\$\$\$\$	\$\$\$
Cycle time / speed	✓✓	~	~	~	~	~	✓✓	✓✓
Cleaning validation complexity	low	low	med	med	low	low	med	high
Global service network	✓✓	✓✓	✓✓	~	✓	✓	✓✓	✓

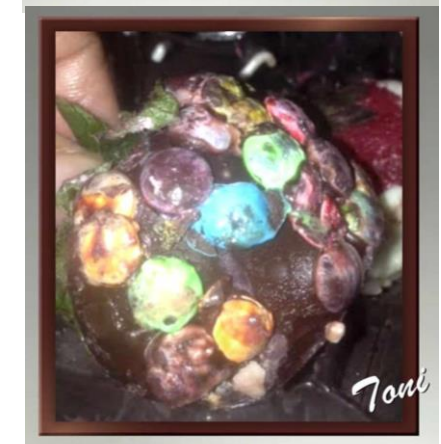

2026 ISPE-Midwest Tech Ed
Symposium & Vendor Showcase

Tuesday, May 19
Overland Park Convention
Center

Thank You

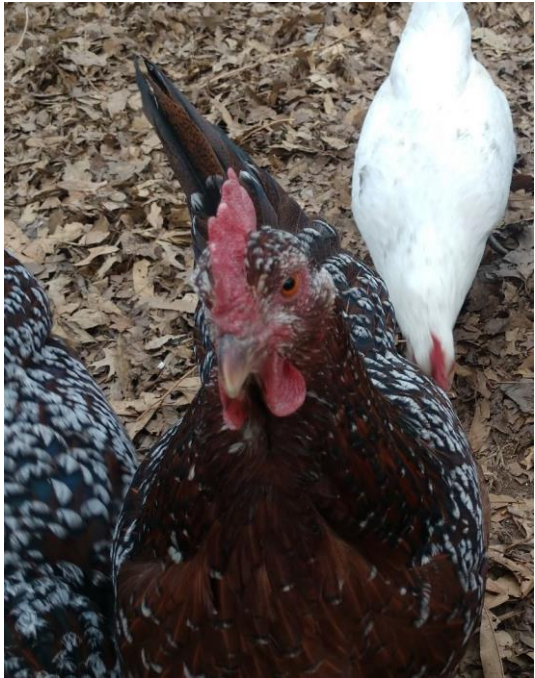

Krishna Bell

kbell@lbbohle.com

m. 816-694-6856

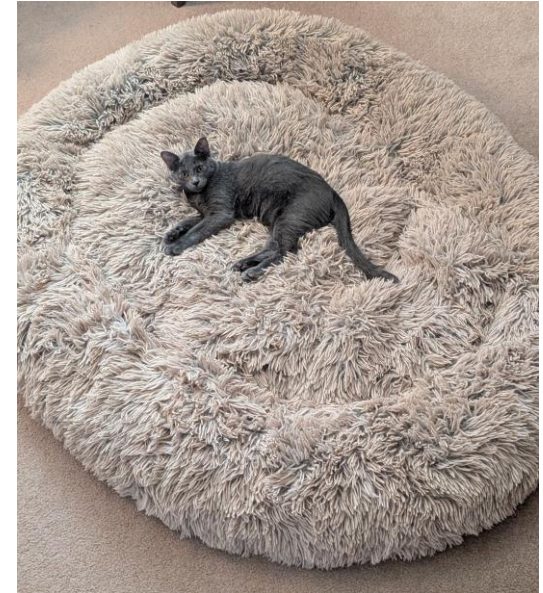

LB BOHLE

2026 ISPE-Midwest Tech Ed
Symposium & Vendor Showcase

Tuesday, May 19
Overland Park Convention
Center

Thank You



Krishna Bell

kbell@lbbohle.com
m. 816-694-6856



LB BOHLE

2026 ISPE-Midwest Tech Ed Symposium & Vendor Showcase

Tuesday, May 19

Overland Park Convention
Center

Thank You



Krishna Bell

kbell@lbbohle.com

m. 816-694-6856

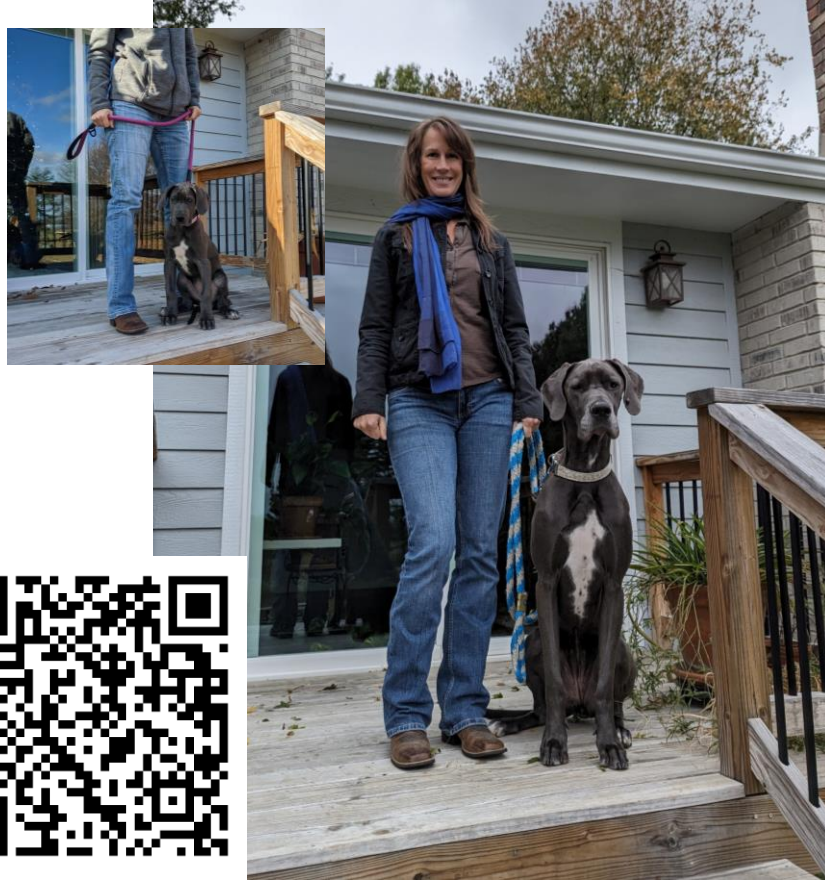

LB BOHLE

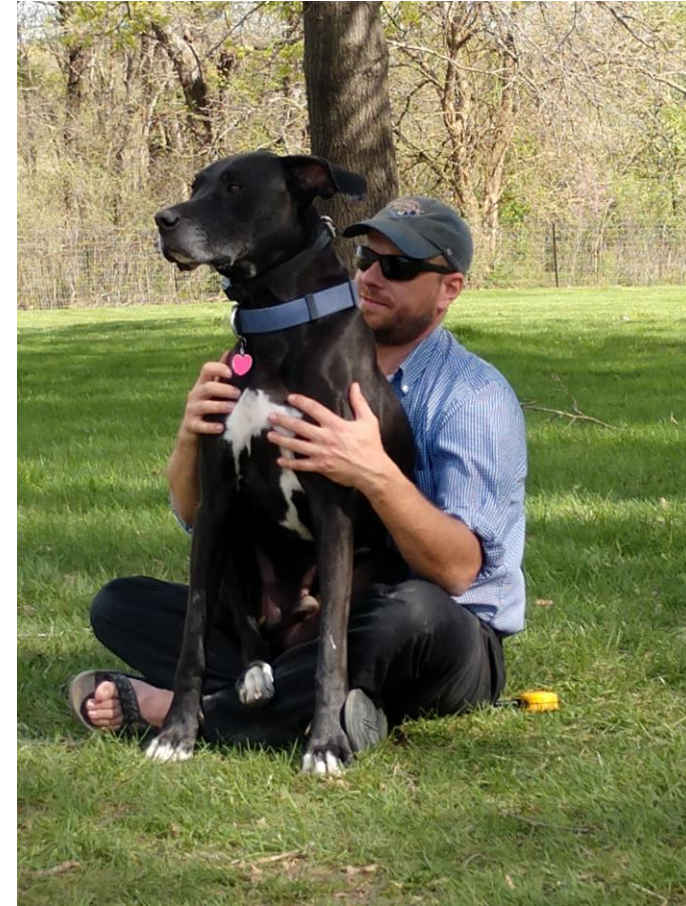

2026 ISPE-Midwest Tech Ed
Symposium & Vendor Showcase

Tuesday, May 19

Overland Park Convention
Center